



Scan the code  
follow Whatsapp



Scan the code  
get the book



شركة تاج الإرتفاع  
للمصاعد المحدودة  
TAJ AL-IRTIFA ELEVATORS LTD

FUJI ELEVATOR CO.,LTD

FUJISJ



This book is a general information publication, and we reserve the right to change the product design and description at any time.  
Any word in this book, regardless of its literal meaning or meaning, shall not be responsible for any product and the use and quality of such product, or for any expression or change of the terms of the purchase and sale contract.  
Due to the limitations of the printing process, the actual processing color may be slightly different from this volume, and the final selection can be determined according to the actual material and color swatch.

FJ-023-01

# FUJISJ PASSENGER ELEVATOR

BASIC SERIES

·PASSENGER ELEVATOR ·OBSERVATION ELEVATOR ·HOSPITAL ELEVATOR



FUJISJ



شركة تاج الإرتفاع  
للمصاعد المحدودة  
TAJ AL-IRTIFA ELEVATORS LTD  
نحن ملتزمون  
بضمان رحلتك الآمنة

FUJISJ

FUJI ELEVATOR CO.,LTD



# FUJISJ ELEVATOR INTRODUCTION ENTERPRISE

Fuji Elevator Co., Ltd and Japan Fuji Machinery & electric Co., limited jointly created the only official Fuji brand in China-FUJISJ. The company has two national standard elevator factories which are located in Suzhou, covering an area of more than 400 acres, has a technical research and development team of nearly 100 people, with an annual output of 20,000 elevators and 2,000 escalators.

We provide high-speed elevators, passenger elevators, home elevators, hospital elevators, observation elevator, escalators, moving walks, freight elevators, automobile elevators etc. The company now has more than 20 series of elevator products with more than 50 specifications, and has reached the domestic and international advanced level. It is one of the largest elevator manufacturers in the elevator industry with complete product specifications, multiple categories, and maximum rated load capacity. We are committed to building the largest elevator production base in the world.

 **20000+** Annual production elevators

 **2000+** Annual production escalators

 **20+** Elevator product series more than

 **50+** Elevator specification more than

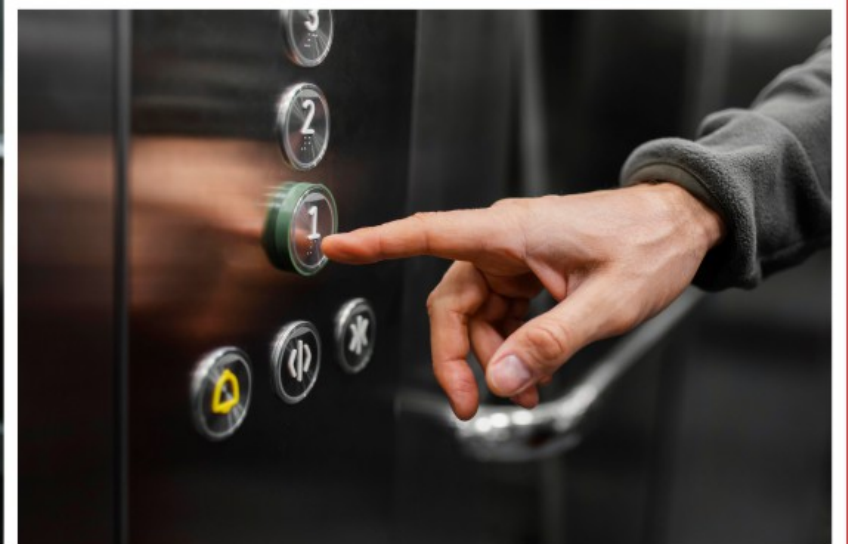

# SCOPE & REQUIREMENTS



Passenger elevator is a vertical lift powered by an electric motor, used to take people in multi-story buildings. Fuji Elevator adopts stable drive design, reliable control system and personalized decoration design to create quiet, smooth and safe elevator products for the world.



## Safe and Reliable

Adopting global leading technology, rigidly and strictly follow German design and manufacturing standards.



## Outstanding Riding Experience

The foaming cabin and silent brake system create a quiet and comfortable riding environment.

## MR Passenger Elevator

### Applicable to

- Residential building
- Commercial building

### Production Range of Application

- Rising height  $\leq 75\text{m}$
- Rate speed  $\leq 1.75\text{m/s}$
- Max.group control number  $\leq 8$  units
- Floor number  $\leq 48$
- Rate capacity  $\leq 1050\text{kg}$
- Traction machine type: Gearless motor

## MRL Passenger Elevator

### Applicable to

- Low and medium rise buildings

### Production Range of Application

- Rising height  $\leq 75\text{m}$
- Rate speed  $\leq 1.75\text{m/s}$
- Max.group control number  $\leq 8$  units
- Floor number  $\leq 48$
- Rate capacity  $\leq 1050\text{kg}$
- Traction machine type: Gearless motor



# SMALL MACHINE ROOM PASSENGER ELEVATOR



## Inner / outer perfection for more superior quality

Compare with traditional elevators, small machine room elevators save 30% of the machine room area, which can reduce effectively construction costs and better adapt to the complex space constraints of modern buildings. It has advantages in saving building space, reducing energy consumption, and improving operating efficiency.

## Reasonable civil engineering arrangement

Realize consistent size between machine room and well, reduce machine room height by 250mm, reserving larger construction space.

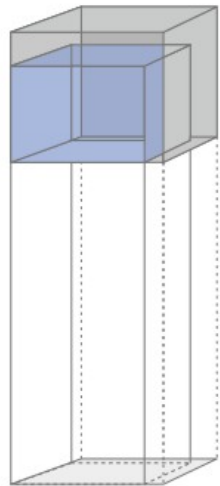

Optimized space of small machine room design reduces the construction cost.

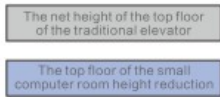

Reduce the area of machine room

**56%**

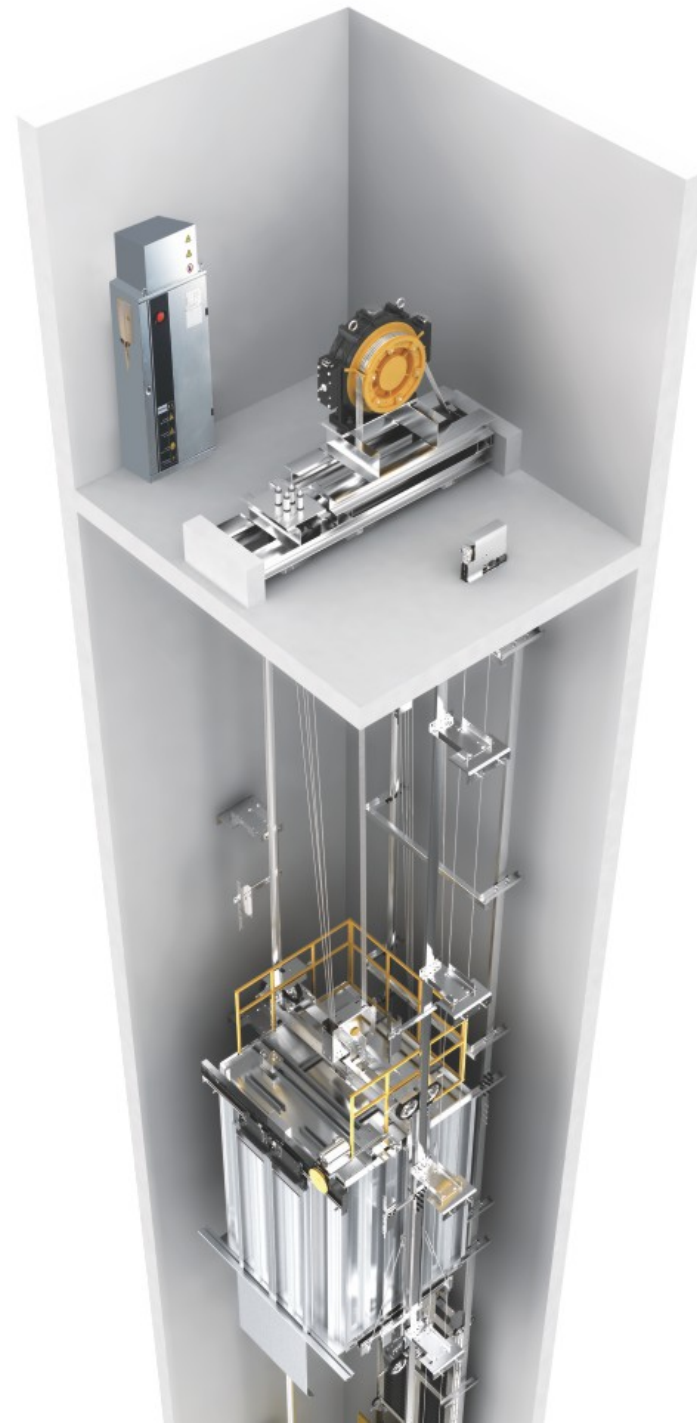

# MACHINE ROOMLESS PASSENGER ELEVATOR

## Easy to integrate enhance the building value

MRL elevator do not require building to provide a closed machine room. The elevator's drive machine, controller cabinet, speed governor and other equipment are miniaturized and moved into the shaft. Significantly save construction area and reduce construction costs. It is conducive to the neat and tidy appearance of the building.

## Low energy consumption space-saving

It is low energy consumption-based. It fully considers building space's utilization rate and cost. Using compact layout and flexible design style and cleverly integrating all kinds of buildings, it is the first choice for modern individualized buildings.

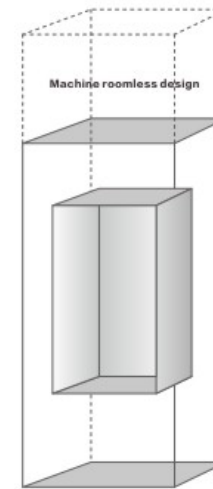

Machine roomless design  
Significantly increase the building area

Achieving 100% utilization of building area

**100%**





**FJ-B-M31** STANDARD CABIN DESIGN

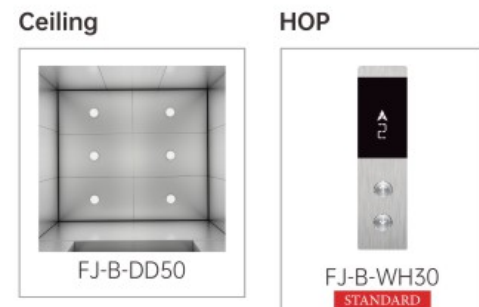
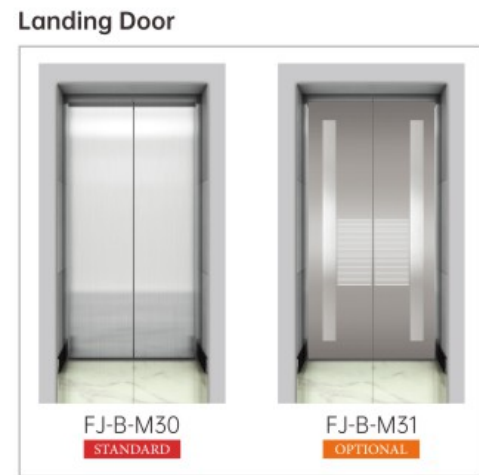

**FJ-B-M32** STANDARD CABIN DESIGN

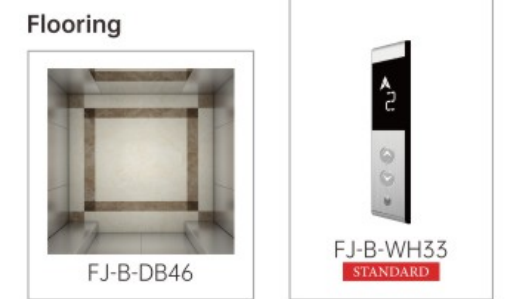
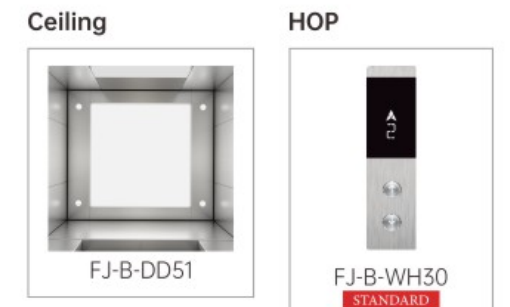
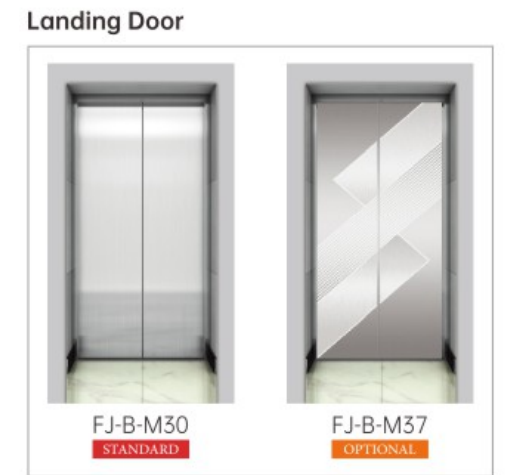

**CABIN DECORATION**

	<b>Ceiling</b>	Stainless steel framework, down lamp
	<b>Ventilation</b>	Axial fan
	<b>Car wall</b>	Hairline stainless steel
	<b>Car door</b>	Hairline stainless steel
	<b>Floor</b>	PVC floor

CD: Customizable, CW: Customizable, HD: Customizable

**COP**



**CABIN DECORATION**

	<b>Ceiling</b>	Stainless steel framework, acrylic light-emitting panel, down lamp
	<b>Ventilation</b>	Axial fan
	<b>Car wall</b>	Hairline stainless steel, mirror stainless steel (Central side of rear wall)
	<b>Car door</b>	Hairline stainless steel
	<b>Floor</b>	PVC floor

CD: Customizable, CW: Customizable, HD: Customizable

**COP**





شركة تاج الإرتفاع  
للمصاعد المحدودة  
TAJ AL-IRTIFA ELEVATORS LTD



**FJ-B-K33** OPTIONAL CABIN DESIGN

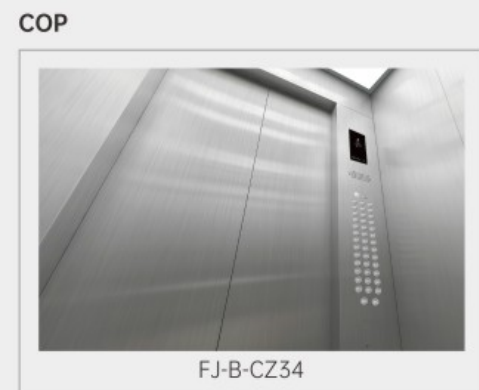
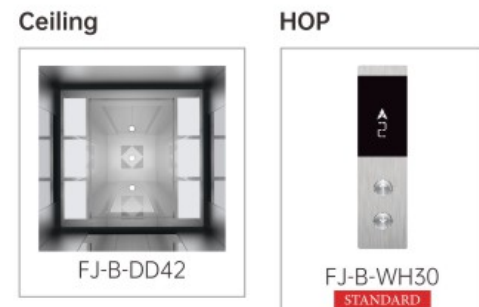

**CABIN DECORATION**

	<b>Ceiling</b>	Mirror stainless steel, acrylicd decoration,down lamp
	<b>Car wall</b>	Hairline stainless steel, mirror etching stainless steel
	<b>Handrail</b>	None
	<b>Car door</b>	Hairline stainless steel
	<b>Floor</b>	PVC floor

CD: Customizable, CW: Customizable, HD: Customizable



**FJ-B-K34** OPTIONAL CABIN DESIGN

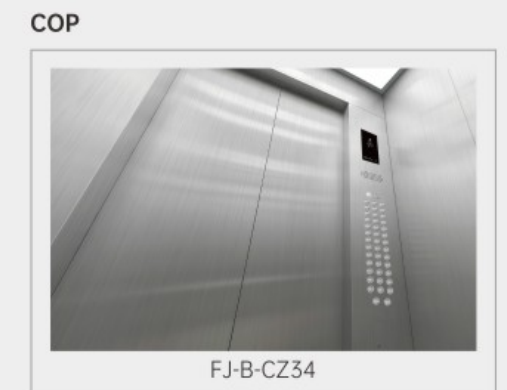
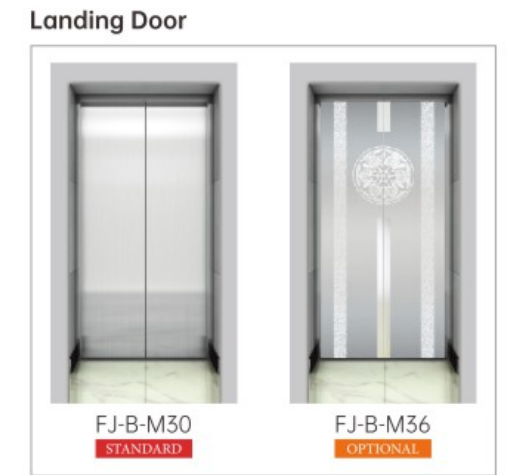

**CABIN DECORATION**

	<b>Ceiling</b>	Hairline stainless steel, acrylicd decoration, towsidetransparent organic light poles
	<b>Car wall</b>	Hairline stainless steel, mirror stainless steel
	<b>Handrail</b>	Stainless steel flat handrail
	<b>Car door</b>	Hairline stainless steel
	<b>Floor</b>	PVC floor

CD: Customizable, CW: Customizable, HD: Customizable



**FJ-B-K35** OPTIONAL  
CABIN DESIGN

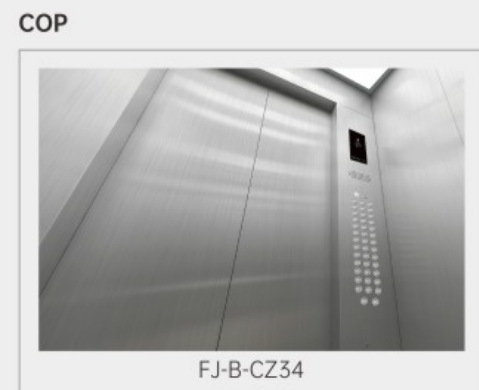
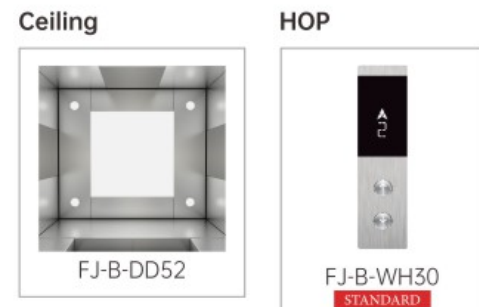
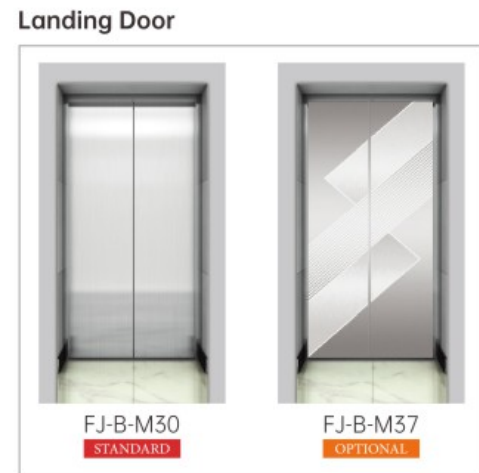

**CABIN DECORATION**

 <b>Ceiling</b>	Hairline stainless steel, acrylic transparent plate, down lamp
 <b>Car wall</b>	Hairline stainless steel, mirror stainless steel
 <b>Handrail</b>	None
 <b>Car door</b>	Hairline stainless steel
 <b>Floor</b>	PVC floor





CD: Customizable, CW: Customizable, HD: Customizable

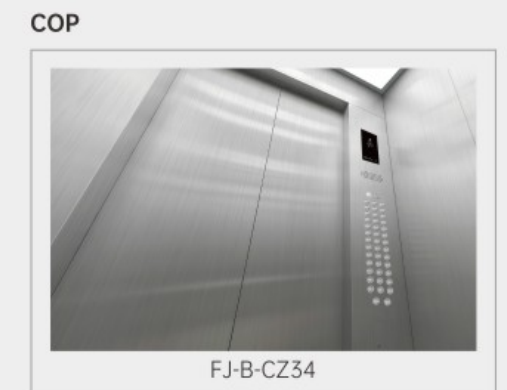
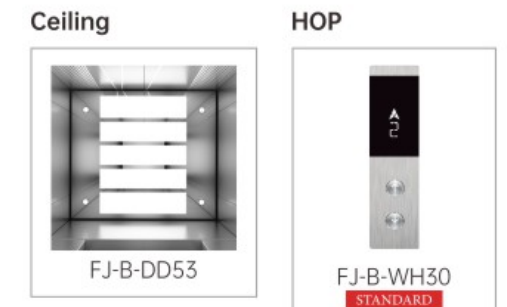
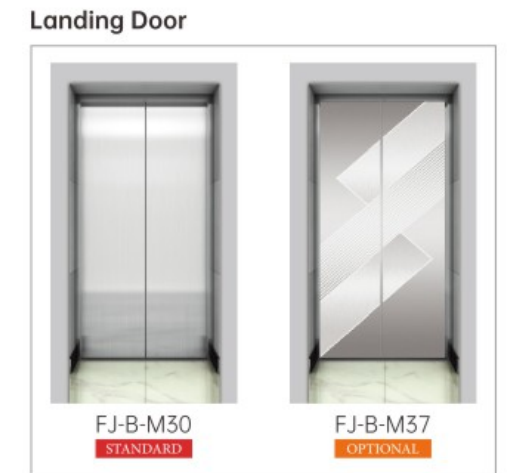

**FJ-B-K36** OPTIONAL  
CABIN DESIGN



**CABIN DECORATION**

 <b>Ceiling</b>	Mirror stainless steel top, acrylic transparent plate, down lamp
 <b>Car wall</b>	Hairline etching stainless steel, Hairline stainless steel
 <b>Handrail</b>	Hairline stainless steel round handrail
 <b>Car door</b>	Hairline stainless steel
 <b>Floor</b>	PVC floor

CD: Customizable, CW: Customizable, HD: Customizable



FJ-B-K37 **OPTIONAL** CABIN DESIGN

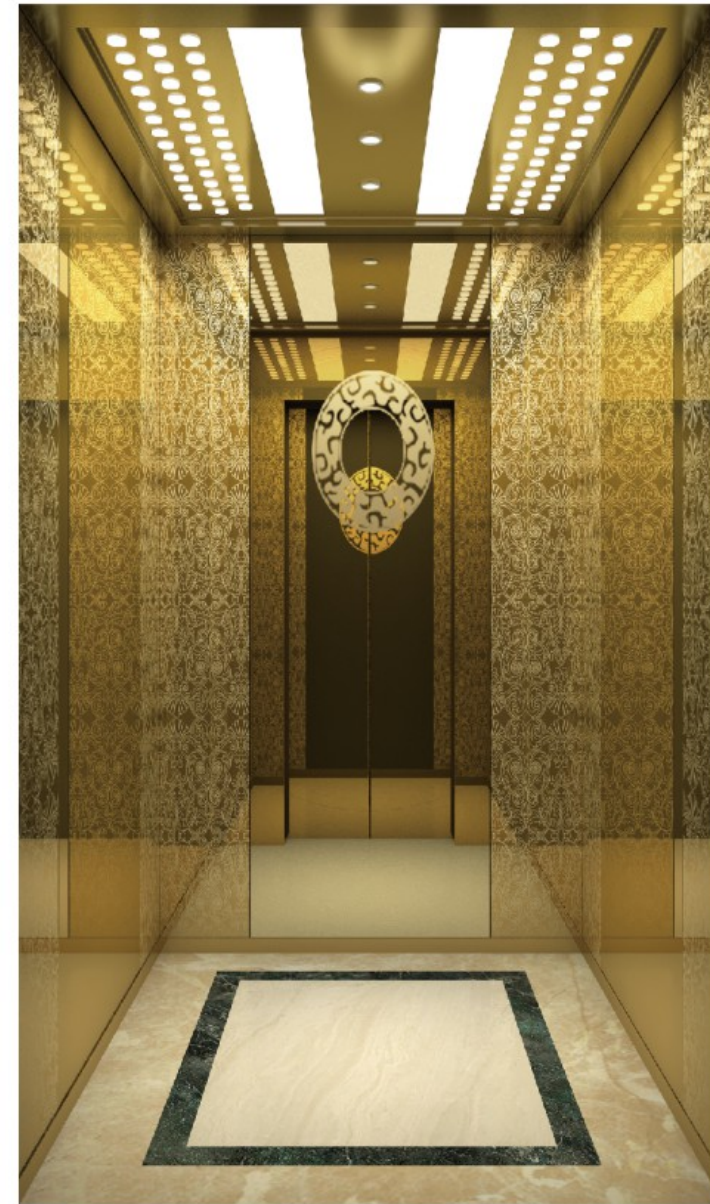
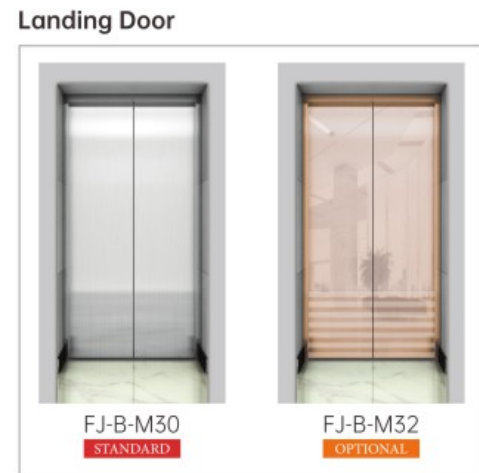

FJ-B-K38 **OPTIONAL** CABIN DESIGN

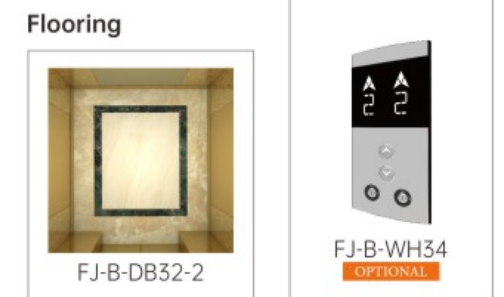
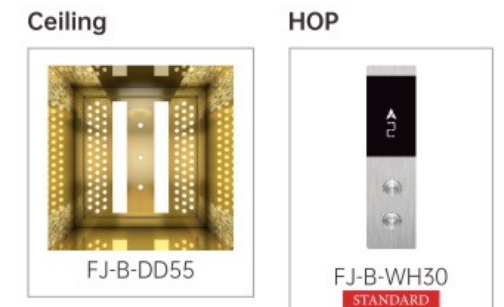
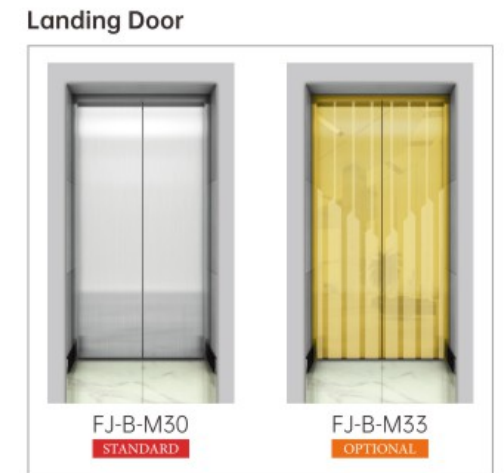

**CABIN DECORATION**

- Ceiling** Rose gold frame, acrylic translucent panel
- Car wall** Rose golden hairline stainless steel, rose golden mirror stainless etching
- Handrail** Rose golden stainless flat handrail
- Car door** Stainless steel with rose golden hairline stainless
- Floor** PVC floor

CD: Customizable, CW: Customizable, HD: Customizable

**COP**



**CABIN DECORATION**

- Ceiling** Titanium stainless steel, acrylic lamp, transparent on both sides organic lamp post
- Car wall** Mirror stainless steel, titanium mirror etching stainless steel
- Handrail** None
- Car door** Mirror stainless steel
- Floor** PVC floor

CD: Customizable, CW: Customizable, HD: Customizable

**COP**



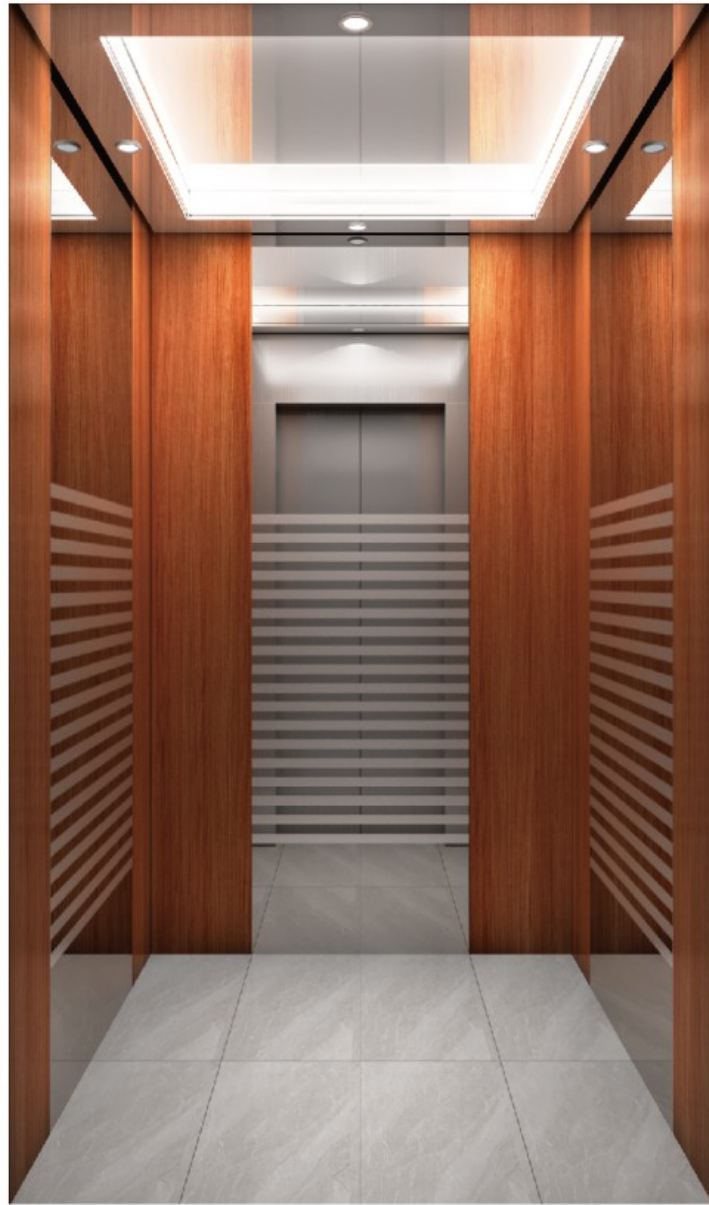

FJ-B-K39 OPTIONAL CABIN DESIGN

Handrail

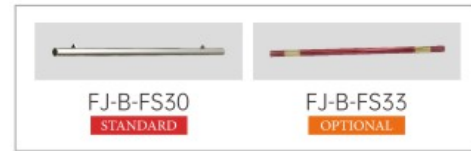

Landing Door



Ceiling



HOP



Flooring



FJ-B-K40 OPTIONAL CABIN DESIGN

Handrail

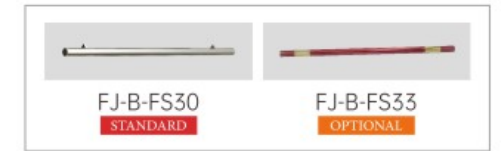

Landing Door



Ceiling



HOP



Flooring



CABIN DECORATION

- Ceiling: Mirror stainless steel, hidden lamptape, down lamp
- Car wall: Mirror etching stainless steel, wood decorative surface
- Handrail: None
- Car door: Hairline stainless steel
- Floor: PVC floor

COP



CD: Customizable, CW: Customizable, HD: Customizable

CABIN DECORATION

- Ceiling: Stone wash stainless, off-white wooden decorative lines
- Car wall: Beige marble, wooden veneer
- Handrail: Wooden handrail, hairline stainless
- Car door: Champagne hairline stainless
- Floor: PVC floor

COP

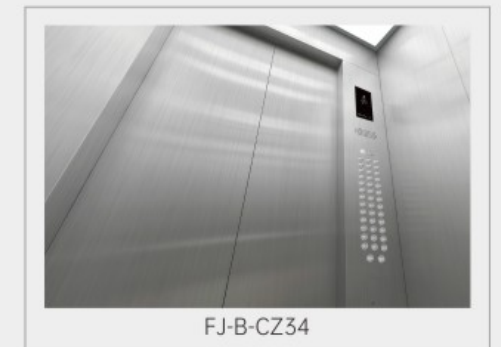

CD: Customizable, CW: Customizable, HD: Customizable



# OBSERVATION ELEVATOR

Fuji Observation Elevator perfectly combines modern aesthetics with elevator design, providing various exterior shapes and interior decoration solutions, making elevators a flowing scenery in modern buildings.

## Custom design

Diverse decoration styles and component selections can also be customized according to user preferences to create exclusive works of art.

## Extra large field of view

Equipped with a large viewing surface, it is spacious and bright, allowing the narrow elevator space to be extended, creating a better viewing experience for users.

## Various shapes

Various car shapes are available, such as semicircular, diamond, rectangular, and outlook type, which can perfectly match different buildings.

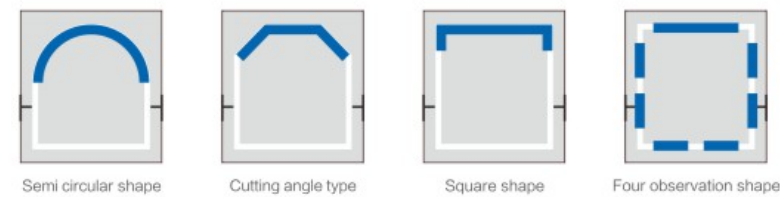

Graphic blue line part shows panorama face transparent glass.



# OBSERVATION ELEVATOR

CABIN DESIGN



FJ-B-G30

- Up and bottom covers**  
Steel plate baked enamel
- Observation wall**  
Laminated safety glass (3 pcs)
- Ceiling**  
Steel plate baked enamel, Acrylic top panel
- Car wall**  
Hairline stainless steel
- Handrail**  
Φ 25 stainless steel triple tubes
- Floor**  
PVC, optional marble
- Car door**  
Hairline stainless steel

FJ-B-G31

- Up and bottom covers**  
Steel plate baking paint, hairline stainless steel, acrylic lighting
- Observation wall**  
Laminated safety glass
- Ceiling**  
Steel plate paint baking frame, acrylic lighting
- Car wall**  
Hairline stainless steel
- Handrail**  
Stainless steel single pipe
- Floor**  
PVC floor
- Car door**  
Hairline stainless steel



شركة تاج الإرتفاع  
للمصاعد المحدودة  
TAJ AL-IRTIFA ELEVATORS LTD

- CE certification
- EAC certification
- Light curtain protection
- Video surveillance
- Emergency leveling
- Environmentally green
- Smooth comfortable



FJ-B-G32

- Up and bottom covers**  
Spray-coated steel plate
- Observation wall**  
Safety laminated glass
- Ceiling**  
Hairline stainless steel, acrylic lighting
- Car wall**  
Hairline stainless steel
- Handrail**  
Triple tube stainless steel
- Floor**  
PVC floor
- Car door**  
Hairline stainless steel

FJ-B-G33

- Up and bottom covers**  
Hairline stainless steel
- Observation wall**  
Safety laminated glass
- Ceiling**  
Mirror stainless steel, acrylic light-emitting panel, led light
- Car wall**  
Hairline stainless steel, safety laminated glass
- Handrail**  
Stainless steel single tube
- Floor**  
PVC floor
- Car door**  
Hairline etched stainless steel

FJ-B-G34

- Up and bottom covers**  
Spray-coated steel plate
- Observation wall**  
Safety laminated glass
- Ceiling**  
Steel plate baked paint roof, inlaid acrylic lighting
- Car wall**  
Hairline stainless steel, Safety laminated glass
- Handrail**  
Stainless steel single tube
- Floor**  
PVC floor
- Car door**  
Hairline stainless steel

# HUMAN MACHINE INTERFACE

CABIN DESIGN



COP



FJ-B-CZ33  
STANDARD

HOP



FJ-B-WH30  
STANDARD



FJ-B-WH33  
STANDARD

COP



FJ-B-CZ32  
OPTIONAL

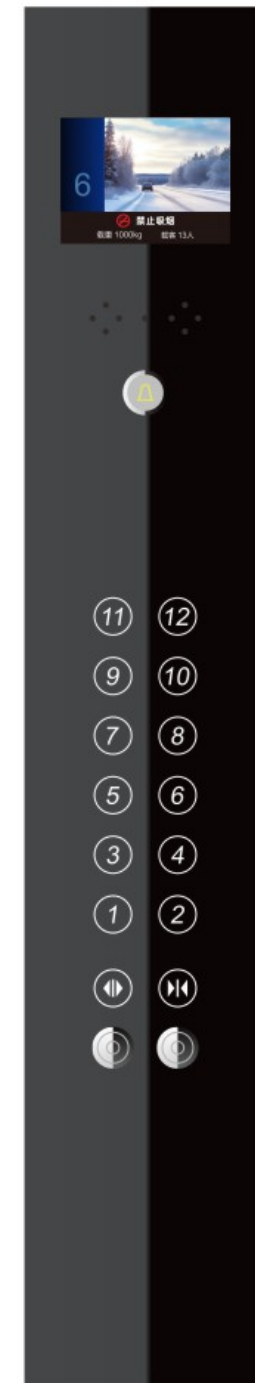

FJ-B-CZ35  
OPTIONAL

HOP



FJ-B-WH32  
OPTIONAL



FJ-B-WH35  
OPTIONAL



FJ-B-WH34  
OPTIONAL



FJ-B-WH36  
OPTIONAL

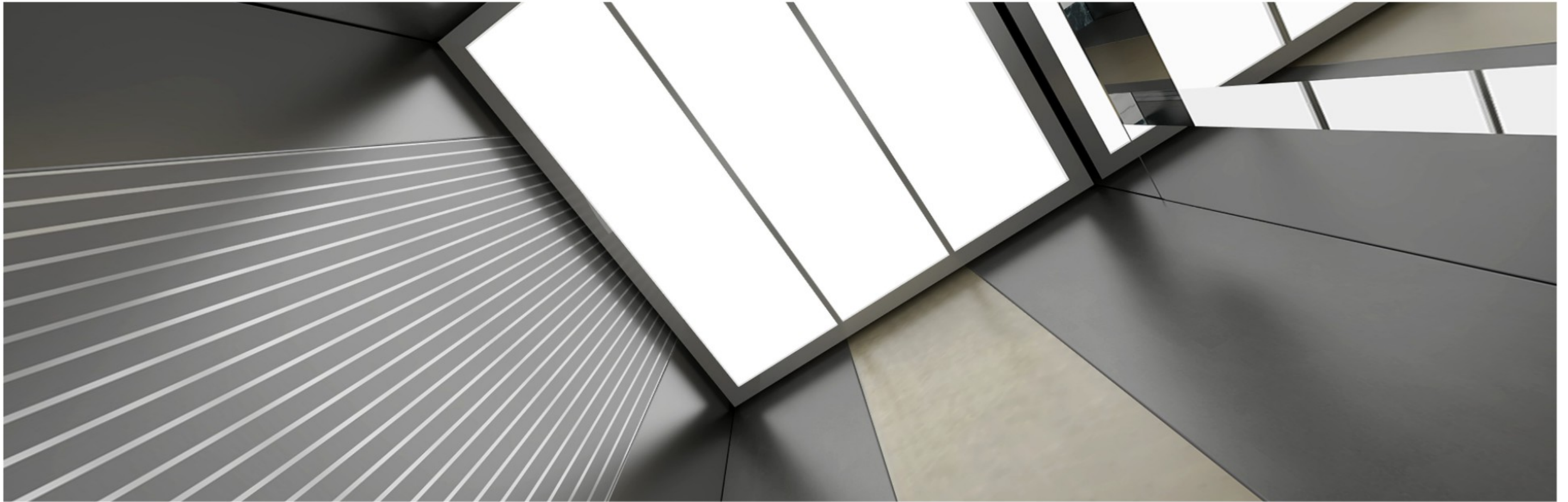

# CEILING SERIES CABIN DESIGN



FJ-B-DD30  
OPTIONAL

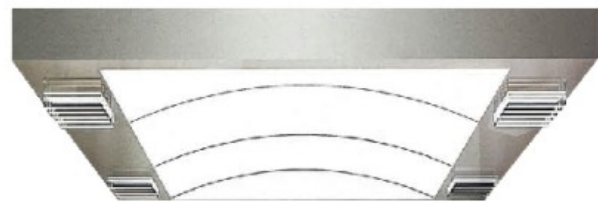

FJ-B-DD31  
OPTIONAL



FJ-B-DD32  
OPTIONAL



FJ-B-DD33  
OPTIONAL

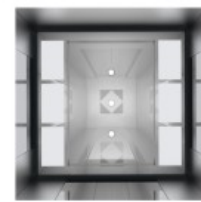

FJ-B-DD42  
OPTIONAL



FJ-B-DD49  
OPTIONAL

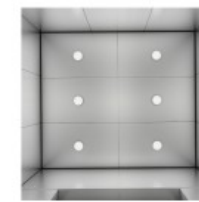

FJ-B-DD50  
OPTIONAL



FJ-B-DD51  
OPTIONAL

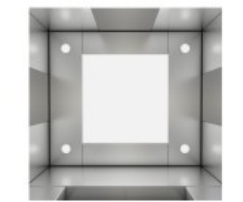

FJ-B-DD52  
OPTIONAL

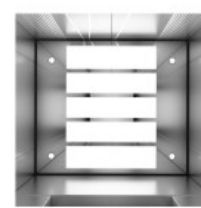

FJ-B-DD53  
OPTIONAL



FJ-B-DD54  
OPTIONAL



FJ-B-DD55  
OPTIONAL

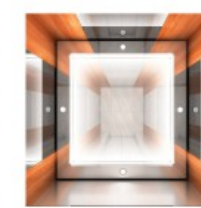

FJ-B-DD56  
OPTIONAL



FJ-B-DD57  
OPTIONAL

# FLOOR SERIES **CABIN DESIGN**



FJ-B-DB30  
STANDARD



FJ-B-DB31  
STANDARD

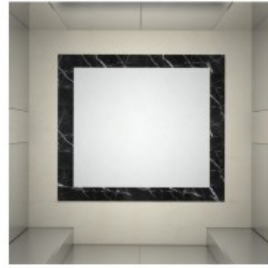

FJ-B-DB31-2  
STANDARD

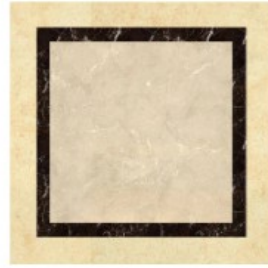

FJ-B-DB32  
STANDARD

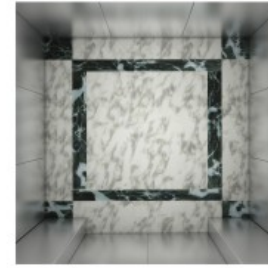

FJ-B-DB45  
OPTIONAL

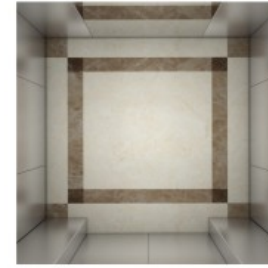

FJ-B-DB46  
OPTIONAL

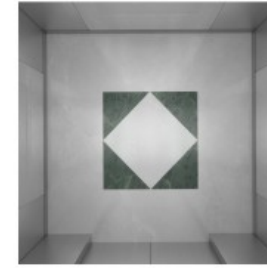

FJ-B-DB47  
OPTIONAL



FJ-B-DB48  
OPTIONAL



FJ-B-DB32-2  
OPTIONAL



FJ-B-DB33  
OPTIONAL



FJ-B-DB34  
OPTIONAL

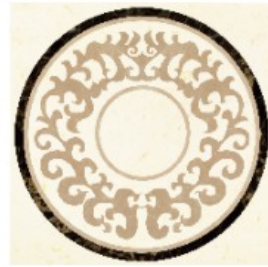

FJ-B-DB35  
OPTIONAL



FJ-B-DB49  
OPTIONAL

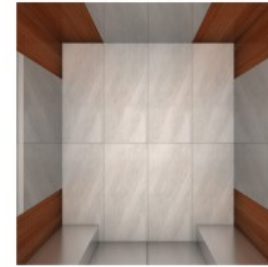

FJ-B-DB50  
OPTIONAL



FJ-B-DB51  
OPTIONAL

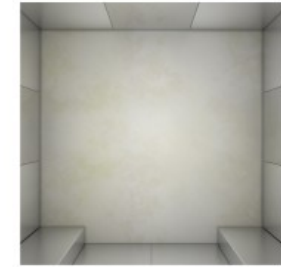

FJ-B-DB52  
OPTIONAL





## HANDRAIL SERIES CABIN DESIGN

FJ-B-FS30  
STANDARD



FJ-B-FS31  
OPTIONAL



FJ-B-FS32  
OPTIONAL

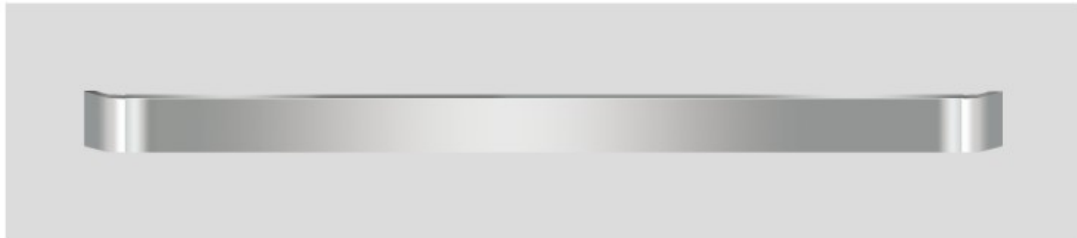

FJ-B-FS33  
OPTIONAL

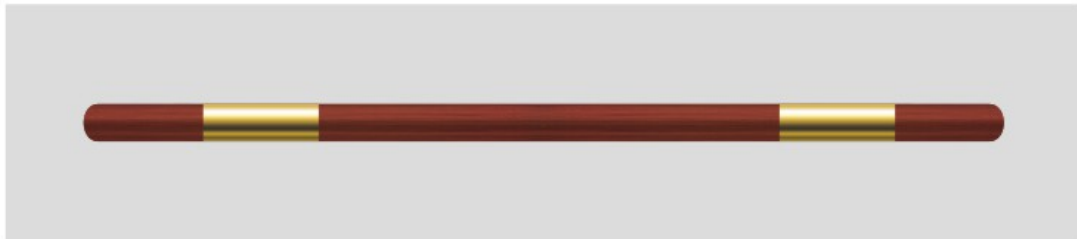

## LANDING DOOR SERIES CABIN DESIGN



FJ-B-M30  
STANDARD



FJ-B-M31  
OPTIONAL



FJ-B-M32  
OPTIONAL



FJ-B-M33  
OPTIONAL



FJ-B-M34  
OPTIONAL



FJ-B-M35  
OPTIONAL



FJ-B-M36  
OPTIONAL



FJ-B-M37  
OPTIONAL

# HOSPITAL ELEVATOR



Hospital elevators are supporting medical equipment provided for hospitals, nursing homes and other buildings. They are mainly used for transporting passengers, hospital bed stretchers and ambulance medical equipment. Compared with traditional passenger elevators, medical elevators are more conducive to doctors and patients in terms of design structure and elevator functions.



## Operation panel for the disabled

When the elevator makes leveling and waits for passengers, if there is any command register in operation panel for the disabled, then it prolongs door-opening time. (Usually it lasts about 30 second. It can be regulated through parameter.) It is the same if you press "door-opening button" in operation panel for the disabled, door-opening time also lasts longer.



## Multiple door-opening modes for your selection

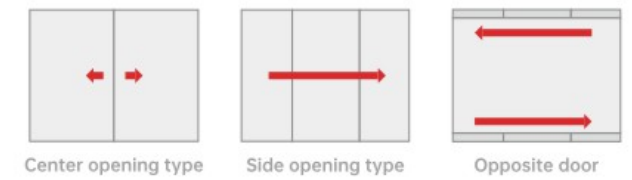

**FJ-B-B31** STANDARD

- Ceiling** Stainless steel framework, acrylic lamp decoration panel
- Car wall** Hairline stainless steel
- Handrail** Stainless steel flat handrail two sides
- Floor** PVC floor
- Car door** Hairline stainless steel



**FJ-B-B32** OPTIONAL

- Ceiling** Stainless steel framework, acrylic arch lighting decoration board
- Car wall** Hairline stainless steel
- Handrail** Stainless steel flat handrail two sides
- Floor** PVC floor
- Car door** Hairline stainless steel

# FUJISJ FELTLESS ELEVATOR

## SAFETY AND COMFORT ELEVATOR TECHNOLOGY INTRODUCTION

### Features Three core technologies

After two years of intensive research by a number of senior engineers, in June 2021, the first feltless elevator was successfully put into use.

Fujisj Elevator is the first company to apply the fusion of perception technology, information computing, and AI intelligence in the field of lifts, combining with the mechanical structure design, to achieve smooth, comfortable, and safe feltless elevator.

### A. Mechanical structure

1. Shock absorbers located below the base of the towing engine: Fig. 1-A (location), Fig. 1-B (FUJISJ);
2. Shock absorber located at the combined end of the rope head of the traction wire rope: Fig. 2-A (ordinary type), Fig. 2-B (FUJISJ);
3. Shock absorbers at the bottom of the car frame located in the lift car: Fig. 3-A (ordinary type), Fig. 3-B (FUJISJ)

FUJISJ Elevator--After tens of thousands of combined gravity compression + buffer experimental parameter tests over the years, we have obtained the optimal elasticity coefficients and optimal fusion damping solutions required by each damping unit for different ladder structures, different speeds and loading conditions. Under the R&D and precision manufacturing of Fuji core technology in Japan, the first FUJISJ senseless lift designed with the best elasticity coefficient and fusion damping structure is created, which perfectly matches the three tests and obtains the best energy-absorbing and damping effect suitable for various ladder types, loads and speeds, thus comprehensively solving all the discomforts brought about by lift vibration.

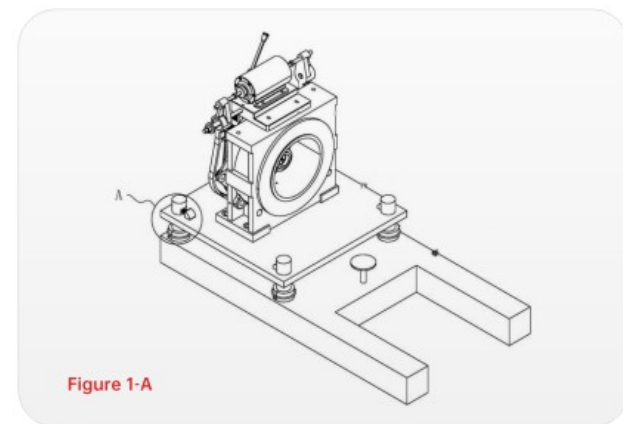

Figure 1-A



Figure 3-B



Figure 1-B

Figure 2-A

Figure 2-B

Figure 3-A

### B. Programming

FUJISJ feltless elevator that operates without feeling subversively changes the control method of the previous lift operation speed command curve, and for the first time in lift equipment, it adopts the adaptive programming design from the traditional input type to the data dictionary. The "input type 7-segment speed control" commonly used in the industry has evolved into "adaptive non-segmental speed control", and the "big and small steps" in the previous speed control curve have been finely ground into "smooth ice". The "ice surface" is incredibly smooth: Fig. 5, allowing people to experience the silky smoothness of a lift that FUJISJ operates without feeling.

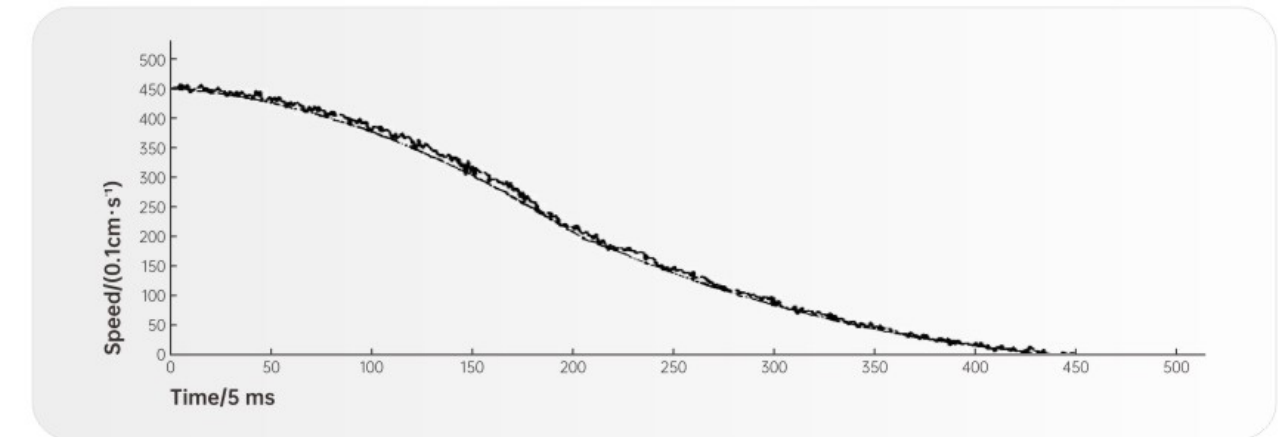

### Data dictionary adaptive techniques

Data structures for programming language application objects are automatically generated by extracting data dictionaries from the data catalogue of the database system and based on the data dictionaries. The application directly uses the application objects defined by these data structures to access the database, and the data dictionary adapts the data objects and objectifies them. A "dynamic coupling" is established between the database and the application objects, resulting in highly accurate adaptive velocity data profiles.

### C. Perception Technology and AI Intelligence

The infinitely weighing start moment compensation algorithm of FUJISJ feltless elevator, plus the parameter auto-tuning design, make the running smoother and make the parameter tuning of the infinitely weighing start more intelligent. It really makes the passengers feel only smooth, comfortable and safe during the whole process of starting, running and stopping the lift.

This is the FUJISJ elevator ---- the founder of feltless elevator!

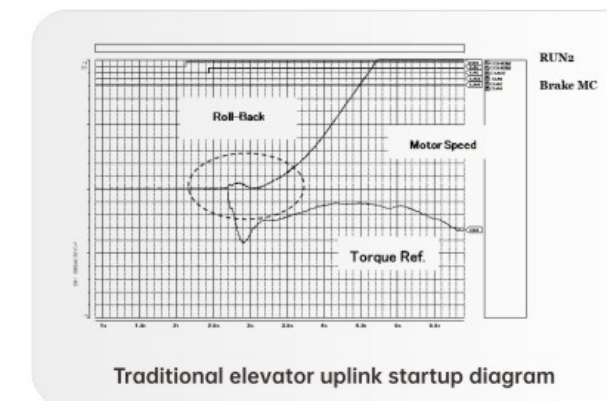

Traditional elevator uplink startup diagram

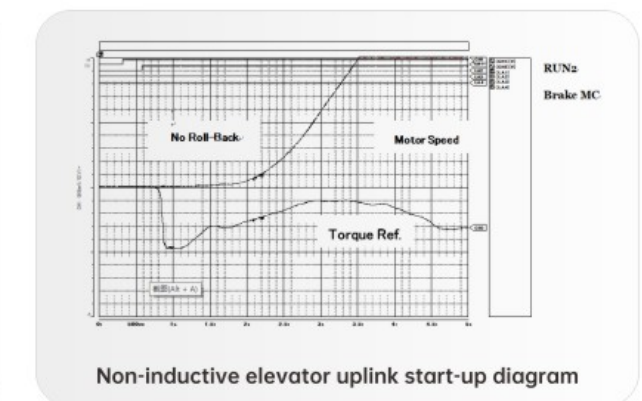

Non-inductive elevator uplink start-up diagram

# FUNCTIONS OF ELEVATOR



General operating function		
Full Set Selection of Running Function	Service floor	Door open time setting function
Door open hold delay function	Service floor Settings for doors	Closing button to close the door in advance
Floor display setting	Light curtain signal self-diagnosis	Repeat closing function
Command independent function	Voice announcement function	Automatic levelling without commissioning
Acceleration section cut-off response	Lower set selection control operation function	Idle return to base station function
Changing station stop function	Forced closing function	Error command deletion function
Service layer setting function	Independent operation	Driver-operated operation
Low-speed self-rescue function	Door control selection function	Outside hall I/O expansion function
Car I/O extension function	Pushbutton sticking check	Starting torque automatic compensation
Direct stop	Optimum curve automatic generation	Suspension of service output function
Record of number of runs	Running time record	Door lock abnormality automatic door opening
VIP service function	Disabled service function	Full Load Direct Drive
Overload protection function	Fault data recording	

Inspection Related Function		
Simple maintenance keypad	Manoeuvring compartment commissioning	Shaft self-learning function
User setting check	Overhaul operation	Motor parameter tuning
Intelligent correction of floor position	Inspection two-stage speed function	Test run

Fire and safety function		
Firefighting forced landing function	Security Floor Function	Lift Lock Function
Troubleshoot faults by classification	Flying Car Prohibition Function	Automatic identification of power failure
Automatic switching of power failure operation mode	Self-recognition of power failure operation direction	Base station verification
Priority release function	Interference evaluation function	Seismic detection function
Current ramp removal	Independent working power supply function	Automatic voltage recognition

Parallel Ladder Operation and Other Functions		
Parallel control/Group control operation	Elevator spread waiting	Exit parallel control/Group control
Automatic disengagement of parallel/group control	Anti-disturbance	Parking in non-door zone indication function
Full load indication function		

Energy Saving Function Configuration		
Car energy saving function	Backup power supply energy-saving operation	Night arrival clock cancellation function

Optional function list		
Early door opening function	Micro-moving level function	Power failure rescue function
On-site commissioning assistance function	Mobile phone debugging function (English version is not supported for the time being)	Residential quarters monitoring function
IC Card Function	STO Function	No machine room monitoring function
Firefighter operation	Auxiliary control compartment function	Front and back door independent control function

# CIVIL ENGINEERING PARAMETERS OF SMALL MACHINE ROOM PASSENGER ELEVATOR

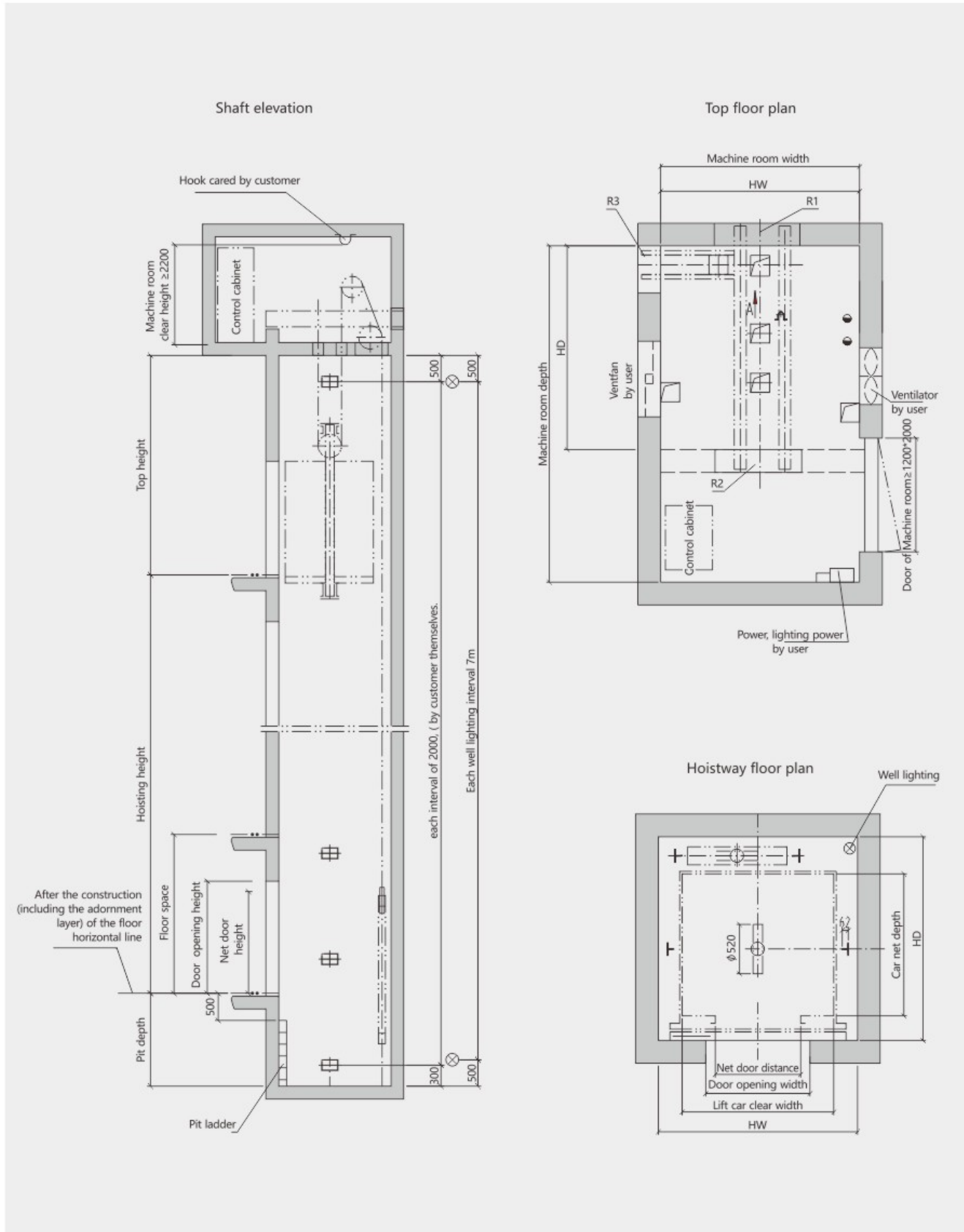

Loading capacity (Passengers)	Rated speed (m/s)	Door opening size (mm)	Car size (mm)			Hoistway size (mm)		Machine room size (mm)			Top height (mm)	Pit depth (mm)	Max travelling height (m)
			Width	Height	Depth	Width	Height	Width	Height	Depth			
450kg (5 Passengers)	1.0	700×2100	1100	1100	2400	1600	1720	$\geq 1600$	$\geq 1720$	$\geq 2200$	4100	1300	60
	1.5										4300	1400	75
630kg (8 Passengers)	1.0	800×2100	1400	1100	2400	1900	1720	$\geq 1900$	$\geq 1720$	$\geq 2200$	4100	1300	60
	1.5										4300	1400	75
	1.75										4300	1400	90
800kg (10 Passengers)	1.0	800×2100	1400	1350	2400	1900	1970	$\geq 1900$	$\geq 1970$	$\geq 2200$	4100	1300	100
	1.5										4300	1400	75
	1.75										4300	1400	90
	2.0										4550	1600	100
	2.5										4800	1700	120
1000kg (13 Passengers)	1.0	900×2100	1600	1500	2400	2100	2150	$\geq 2100$	$\geq 2150$	$\geq 2200$	4100	1300	60
	1.5										4300	1400	75
	1.75										4300	1400	90
	2.0										4550	1600	100
	2.5										4800	1700	120
	3.0										5300	2400	140
Stretcher ladder 1000kg (13 Passengers)	1.0	900×2100	1600	1500	2400	2150	2500	$\geq 2100$	$\geq 2500$	$\geq 2200$	4100	1300	60
	1.5										4300	1400	75
	1.75										4300	1400	90
	2.0										4550	1600	100
	2.5										4800	1700	120
1250kg (16 Passengers)	1.0	1100×2100	1800	1600	2400	2350	2300	$\geq 2350$	$\geq 2300$	$\geq 2200$	4100	1300	60
	1.5										4300	1400	75
	1.75										4300	1400	90
	2.0										4550	1600	100
	2.5										4800	1700	120
	3.0										5300	2400	140
	4.0										6400	5800	190
	8.0										8700	7400	380
1600kg (21 Passengers)	1.0	1100×2100	1800	1850	2400	2350	2550	$\geq 2350$	$\geq 2550$	$\geq 2200$	4100	1300	60
	1.5										4300	1400	75
	1.75										4300	1400	90
	2.0										4550	1600	100
	2.5										4800	1700	120
	3.0										5300	2400	140
	4.0										6400	5800	190
	8.0										8700	7400	1800

Note: Only for reference, final manufacture please follow contract.

# CIVIL ENGINEERING PARAMETERS OF MACHINE ROOMLESS PASSENGER ELEVATOR

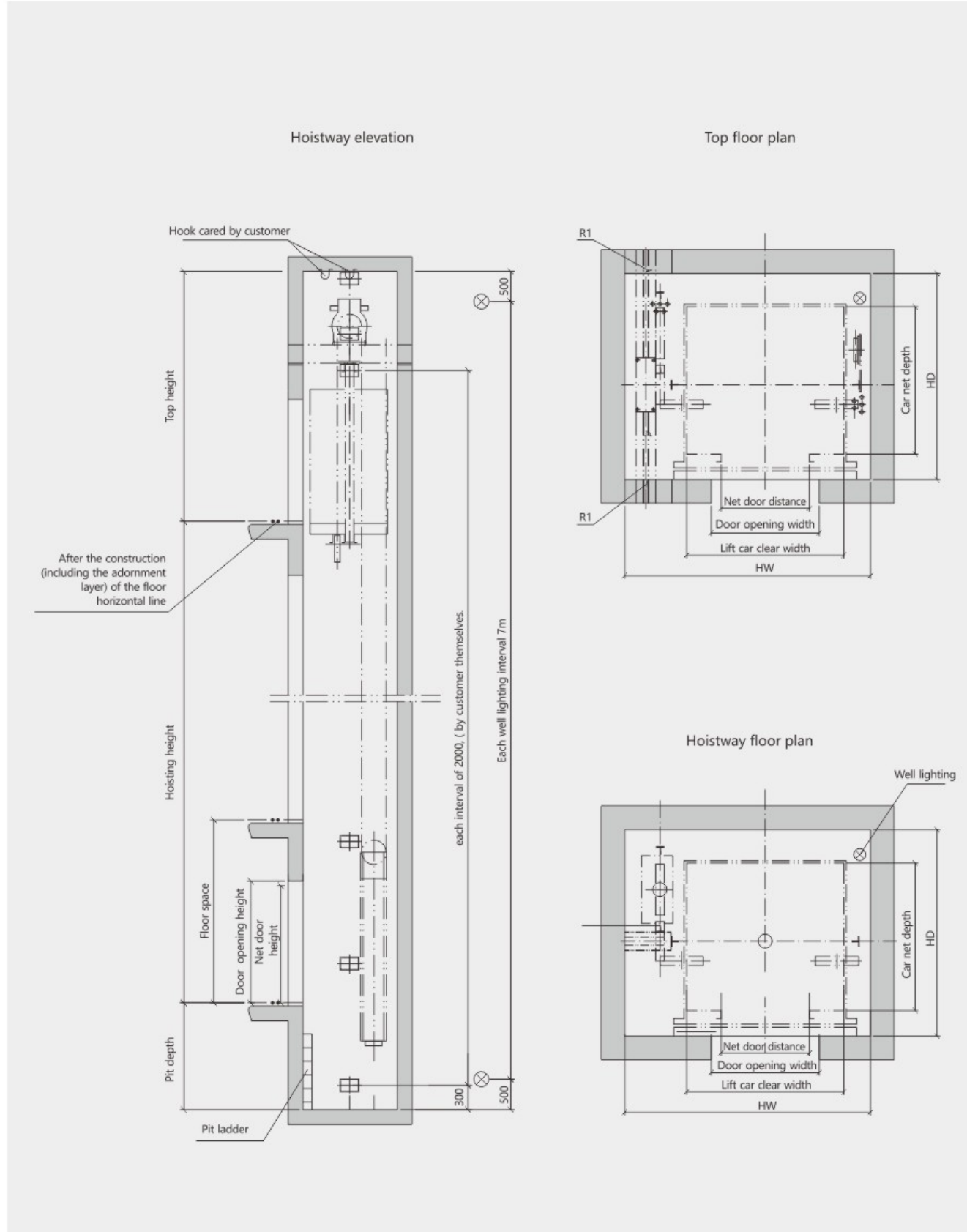

Loading capacity (Passengers)	Rated speed (m/s)	Door opening size (mm)	Car size (mm)			Hoistway size (mm)		Top height (mm)	Pit depth (mm)	Max travelling height (m)
			Width	Height	Depth	Width	Height			
450kg (5 Passengers)	1.0	700×2100	1100	1100	2400	1950	1700	4200	1500	60
	1.5							4400	1600	75
630kg (8 Passengers)	1.0	800×2100	1400	1100	2400	2250	1700	4200	1500	60
	1.5							4400	1600	75
	1.75							4400	1600	90
800kg (10 Passengers)	1.0	800×2100	1400	1350	2400	2250	2000	4200	1500	60
	1.5							4400	1600	75
	1.75							4400	1600	90
1000kg (13 Passengers)	1.0	900×2100	1600	1500	2400	2500	2100	4200	1500	60
	1.5							4400	1600	75
	1.75							4400	1600	90
Stretcher ladder 1000kg (13 Passengers)	1.0	900×2100	1600	1500	2400	2150	2500	4200	1500	60
	1.5							4400	1600	75
	1.75							4400	1600	90
1250kg (16 Passengers)	1.0	1000×2100	1800	1600	2400	2750	2100	4200	1500	60
	1.5							4400	1600	75
	1.75							4400	1600	90
1600kg (21 Passengers)	1.0	1100×2100	1800	1850	2400	2900	2300	4200	1500	60
	1.5							4400	1600	75
	1.75							4400	1600	90

Note: Only for reference, final manufacture please follow contract.



# CIVIL ENGINEERING PARAMETERS OF OBSERVATION ELEVATOR

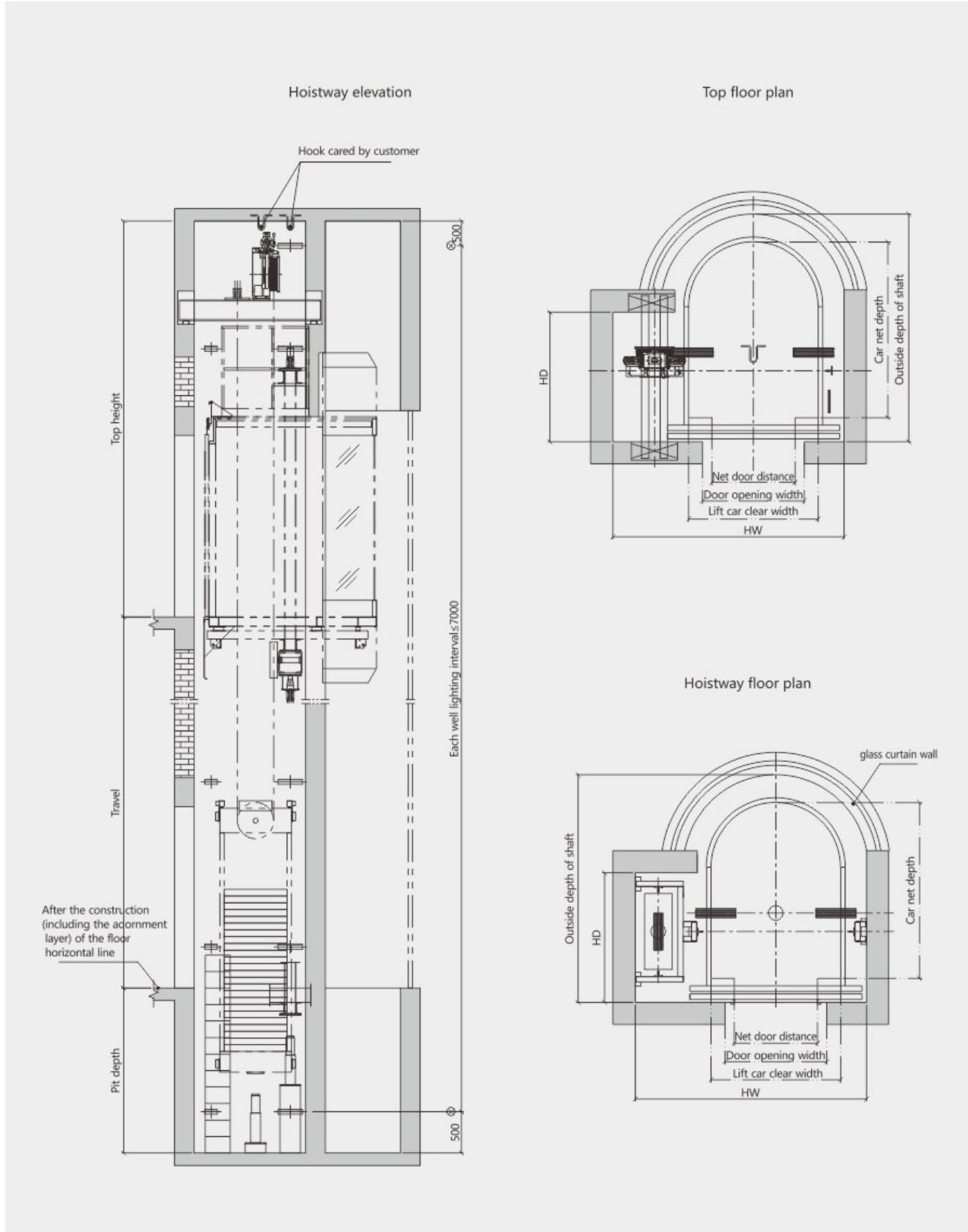

The shape of observation elevator	Loading capacity (Passengers)	Rated speed (m/s)	Door opening size (mm)	Car size (mm)			Hoistway size (mm)		Top height (mm)	Pit depth (mm)	Max travelling height (m)
				Width	Height	Depth	Width	Height			
Square	800kg (10 Passengers)	1.0	800×2100	1400	1100	2400	2250	1700	4500	1600	60
		1.5							4700		75
		1.75							4700		90
	1000kg (13 Passengers)	1.0	900×2100	1400	1350	2400	2250	2000	4500	1600	60
		1.5							4700		75
		1.75							4700		90
Round	800kg (10 Passengers)	1.0	800×2100	1600	1500	2400	2500	2100	4500	1600	60
		1.5							4700		75
		1.75							4700		90
	1000kg (13 Passengers)	1.0	900×2100	1600	1500	2400	2150	2500	4500	1600	60
		1.5							4700		75
		1.75							4700		90

Note: Only for reference, final manufacture please follow contract.

# CIVIL ENGINEERING PARAMETERS OF HOSPITAL ELEVATOR

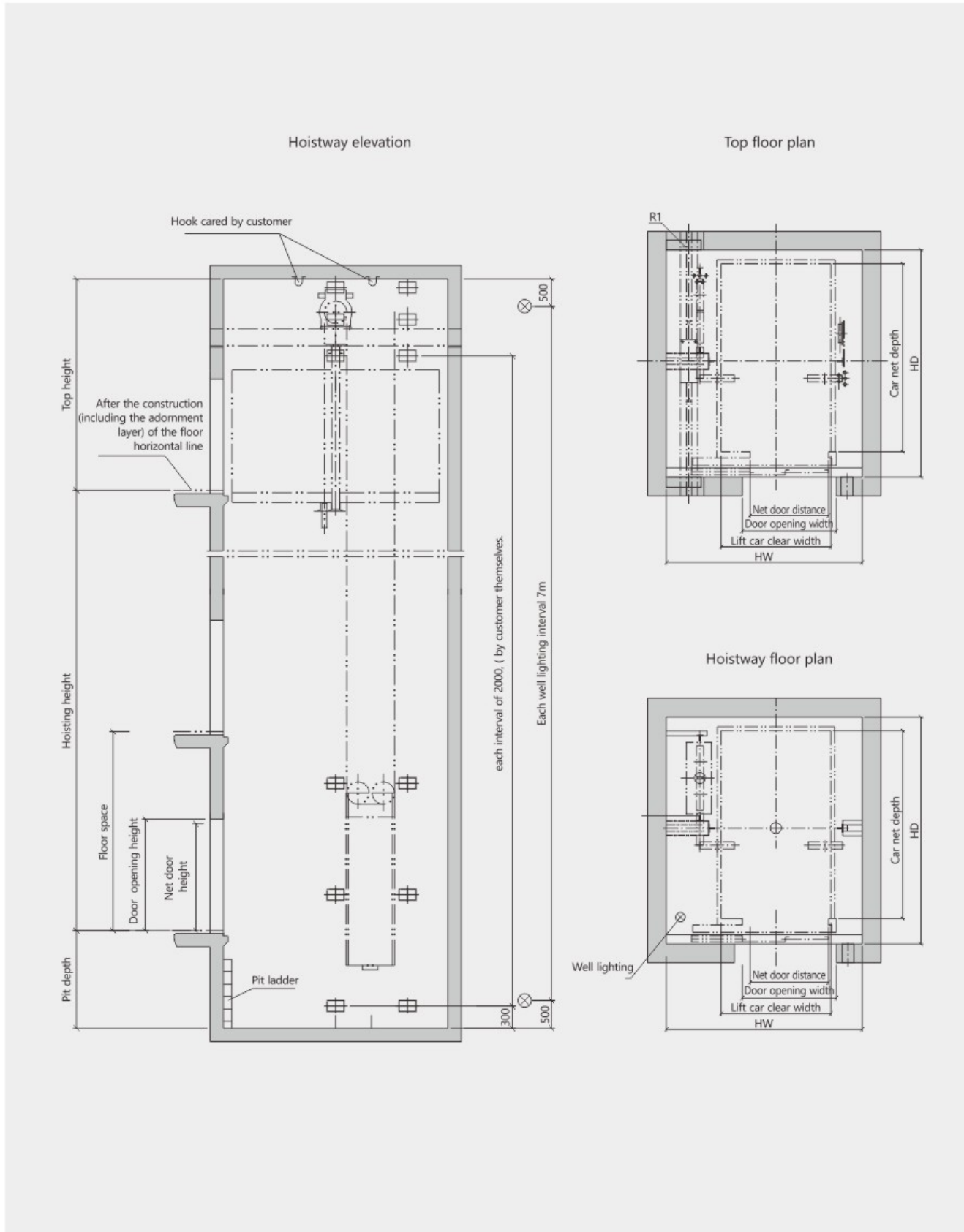

Loading capacity (Passengers)	Rated speed (m/s)	Open the door way	Door opening size (mm)	Car size (mm)			Hoistway size (mm)		Top height (mm)	Pit depth (mm)	Max travelling height (m)
				Width	Height	Depth	Width	Height			
1600kg	1.0	Double discount on the side	1100×2100	1400	2400	2400	2400	2900	4500	1500	60
	1.5								4700	1700	75
	1.75	Middle division	1000×2100	1400	2400	2400	2400	2900	4700	1700	90

Note: Only for reference, final manufacture please follow contract.